

# YOUR RENOVATION GUIDE

STATE-OF-THE-ART WINDOWS AND DOORS



2015



Manufacturer of the Year  
Windows and Doors

ADD BEAUTY, VALUE AND ENERGY EFFICIENCY TO YOUR HOME.



## WELCOME TO ALL WEATHER WINDOWS RENOVATIONS

Thank you for your interest in doors and windows from ALL WEATHER WINDOWS RENOVATIONS.

We created this product guide to help you make informed decisions about which doors and windows are best for your renovation and to showcase the wide range of beautiful, state-of-the-art products we offer you.

As a proud Canadian company, it is our goal to provide Canadians like you with solutions that stand the test of time and climate, whether you face the wet weather of our east and west coasts, the intense summer heat and humidity of central Canada, the unforgiving blizzards of the prairies, or the extreme cold of the far north.

We know Canada, and we design and build our products to meet the unique needs of Canadians. We also know that Canadians love their homes, so we offer the finest in manufacturing quality together with a wide choice of inspiring designs.

I hope you'll find this guide helpful. If you need further assistance, please contact an authorized ALL WEATHER WINDOWS RENOVATIONS Sales Representative, or visit [awwreno.com](http://awwreno.com).

Richard Scott  
President & Chief Executive Officer  
All Weather Windows



# WHAT'S INSIDE

2	Why choose All Weather Windows Renovations
8	Professional Installation Guaranteed
10	Doors Overview
12	Doors Buying Guide
14	Versailles French Doors
16	WeatherGard Sliding Patio Door
18	Everest Sliding Patio Door
19	Element Sliding Patio Door
20	Strong Arm II Garden Doors
22	Strong Arm II Entry Doors
24	Complete Entry Door Line-up
26	Entry Door Decorative Glass
28	Windows Buying Guide
39	<b>METAL CLAD PVC WINDOWS</b>
40	Apex Alloy 9950 Series
42	<b>PVC WINDOWS</b>
43	Magnum 7000 Series
44	EnergySaver 2500 Series
46	Apex 9100 Series
47	Apex 9100 with Renolit
48	Titan 6500 Series
49	Basement Windows
50	Metal Clad Exterior Colours
51	PVC Options
52	Hardware Options
53	Grille/SDL Options
54	Glossary
56	Our History
57	Find us



## WHY ALL WEATHER WINDOWS RENOVATIONS?

**ALL WEATHER WINDOWS** is the largest privately owned window manufacturer in Canada. By continually investing in research and development, we've been able to create the most advanced, attractive and energy efficient doors and windows for your home or business.

Many of our products are industry firsts, and we continually meet and exceed the strictest tests for quality and performance. With our combination of product, service and expertise its no surprise that **ALL WEATHER WINDOWS RENOVATIONS** is an ideal choice for your renovation.

**Use this handy checklist to compare the features of ALL WEATHER WINDOWS to other manufacturers. You'll discover that only ALL WEATHER WINDOWS checks all the boxes.**

	All Weather Windows	Company A	Company B
Alberta made for the Alberta climate	√		
Industry leading design and manufacturer	√		
High performance glass	√		
The most effective warm edge spacer bars	√		
Variety of energy efficient frame materials	√		
CSA® Certified Products	√		
ENERGY STAR® Window and Door Manufacturer of the Year	√		
All vinyl frames are made with virgin PVC only	√		
InstallationMasters™ certified installers	√		
Helpful, no pressure sales service	√		
Fair and open pricing	√		
Excellent value	√		
Financing options	√		
Canadian owned and operated	√		
35+ years of experience	√		
One of Canada's 50 Top Managed Companies	√		
Serving Canada coast to coast	√		
Member, Canadian Home Builders Association	√		
Better Business Bureau Accredited A+ rating	√		



## INNOVATIVE PRODUCTS BACKED BY LEAK-PROOF WARRANTIES

We continually invest in research and development to find innovative ways to make windows and doors more beautiful, more efficient and more durable – like our high performance V-weld combination windows. That's why we're confident enough to support all our products with industry leading warranties. When you choose All Weather Windows, you can feel secure with warranties that include:

- 20 years on sealed (glass) units and vinyl (PVC) components
- 10 years on peeling, bubbling, cracking, flaking or chipping of paint on metal or PVC
- 5 years on steel & fiberglass doors
- 2 years on wood metal clad doors
- 1 year on spontaneous glass breakage
- Transferable for single family stand alone residences



## WE GIVE BACK TO THE COMMUNITIES IN WHICH WE WORK

When you choose ALL WEATHER WINDOWS RENOVATIONS, you'll be working with a company that gives back to communities where we do business.

We have supported over 67 charitable causes across Canada. In 2001, we embarked on a major partnership with Habitat for Humanity, an international organization dedicated to providing safe, decent and affordable housing to communities in need.

In addition to the financial commitment made by the organization, many of our employees volunteer for builds in their local communities.





### SAVE GREEN WHILE BEING GREEN

All our windows are built to the highest energy efficient standards, consistently earning us ENERGY STAR® awards year after year. In fact, we were named ENERGY STAR® Manufacturer of the Year 4 out of the last 5 years! ENERGY STAR® certified windows will save you money by reducing overall annual energy costs plus they will help keep your home more comfortable year-round. Not all ENERGY STAR® products are certified for the same zone though – be sure that you are buying ENERGY STAR® products that are certified for where you live. We are proud to offer windows that meet all zone requirements and Alberta building code specifications for new homes so you'll have peace of mind for years to come.

### CALCULATE YOUR SAVINGS

To find out how much you can save on your energy bills with our windows, use the Energy Saver Calculator at [awwreno.com](http://awwreno.com).

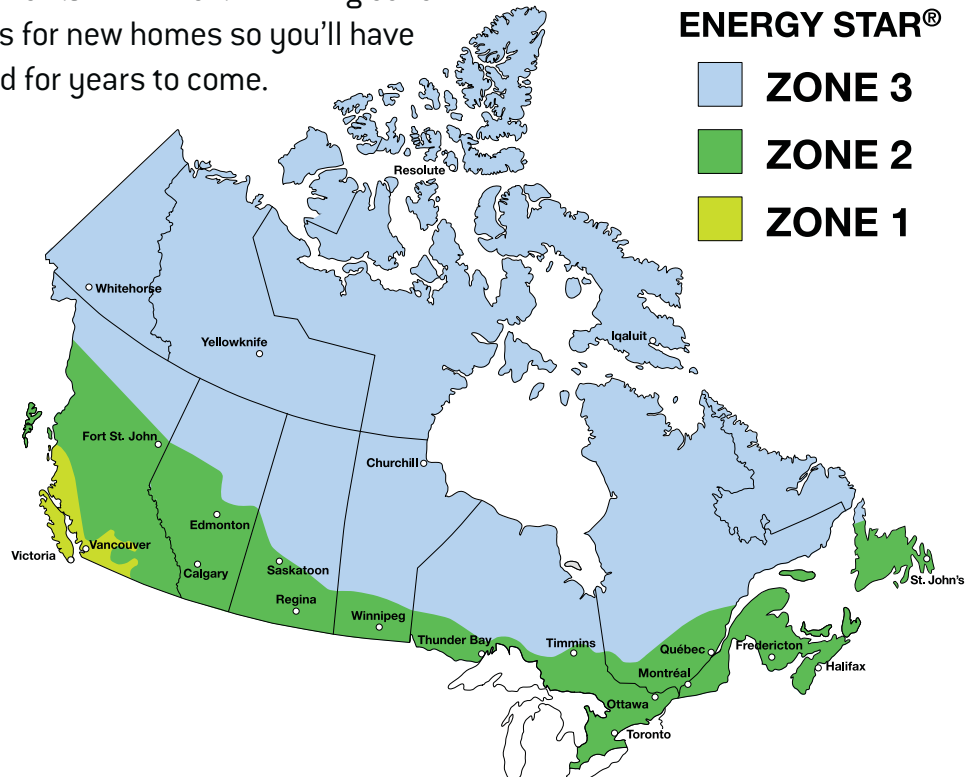



## AN ALBERTA COMPANY MEETING THE NEEDS OF ALBERTANS

ALL WEATHER WINDOWS RENOVATIONS is dedicated to designing and creating windows and doors that are ideally suited to the Alberta climate. Built by Albertans for Albertans, our products undergo extensive testing right here where our customers live and work, enabling us to deliver innovative solutions that are proven to withstand the harshest extremes of Alberta weather.

## FINANCING

Your home renovation is a valuable investment, and we can make it easier to move forward with flexible financing solutions for qualified customers. Talk to your ALL WEATHER WINDOWS RENOVATIONS sales representative about a customized monthly payment plan that works for you.



# AN INTRODUCTION TO V-WELD INNOVATION

All Weather Windows is proud to be one of the first manufacturers in North America to launch the groundbreaking technology of V-weld as part of our Apex window series. No other window offers such exceptional performance in keeping the outside elements from seeping into a home—virtually eliminating air and water leaks.

## V-WELD IS MORE THAN JUST A FANCY SOUNDING NAME

Conventional windows use mechanical mullions joined with gaskets and silicone, which contract and expand with temperature differences. This can lead to separation between joints, causing air and water leaks. To eliminate this, V-weld Apex windows are fusion-welded together leaving no gaps, cracks, spaces, slits or any other synonyms that water can seep through. This manufacturing process provides superior frame integrity and ensures better performance than conventional combination windows in water and air tests.

### V-WELD PRODUCTS

#### APEX (PVC WINDOW)

- 9100 SERIES
- 9100 SERIES WITH RENOLIT

#### APEX ALLOY (METAL CLAD PVC WINDOW)

- 9950 SERIES

### V-WELD WINDOW TECHNOLOGY



Fusion-welded combination window

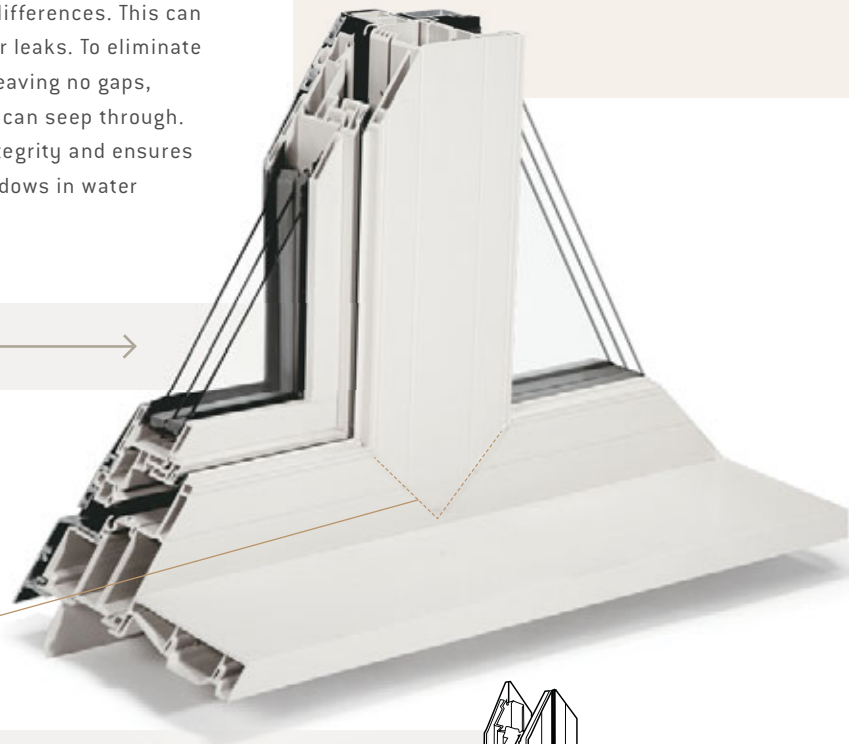

### TRADITIONAL WINDOW TECHNOLOGY

Combination window joined together with screws

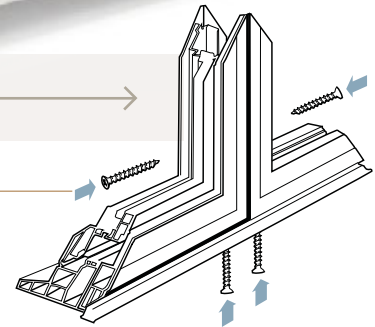



# RECOGNIZING GOOD VALUE

## WHO IS CSA INTERNATIONAL?

CSA International tests products for compliance to national and international standards, and issues certification marks for qualified products. The CSA mark assures consumers that a product has been evaluated by a formal process that involves examination, testing and follow-up inspection, and that it complies with applicable standards for safety and performance.



## CSA® CERTIFIED PRODUCTS

Products certified under CSA® International's Windows and Doors Certification Program will carry the CSA® mark. All our products have been CSA® certified and have earned the CSA® mark for having met stringent testing requirements.

Learn more about CSA® certification at [csagroup.org](http://csagroup.org)

## PERFORMANCE RATINGS

The standards allow for several levels of performance for:

- air tightness (A)
- water tightness (B)
- wind load resistance (C)
- forced entry resistance (F)
- screen strength/ease of operation (S/E)
- condensation resistance (I) (optional)
- energy rating (ER) (optional)

In each area, the higher the number, the better the performance.

## AIR TIGHTNESS (A)

Performance is indicated by a number rating from A1 to A3.

Windows	Sliding Doors
A1	A1
A2	A2
A3	A3

Insulated steel doors are tested on a pass/fail basis and do not receive a graduated rating.

## WATER TIGHTNESS (B)

Performance is indicated by a number ranging from B1 to B7 for windows, and from B1 to B4 for sliding doors.

Windows	Sliding Doors
B1	B1
B2	B2
B3	B3
B4	B4
B5	
B6	
B7	

Insulated steel doors are tested on a pass/fail basis and do not receive a graduated rating.

## WIND LOAD RESISTANCE (C)

There are up to five levels of wind resistance for windows (C1 to C5) and three levels (C1 to C3) for sliding doors.

Windows	Sliding Doors
C1	C1
C2	C2
C3	C3
C4	
C5	

Insulated steel doors are not tested for wind load resistance.

## FORCED ENTRY RESISTANCE (F)

For windows, an F10 rating means that the window meets the standard level of resistance to forced entry. An F20 rating indicates that the window has achieved a higher level of resistance to forced entry.

All sliding doors must have a lock or latching device.

An F10 or F20 rating indicates that the product has passed forced-entry resistance testing.



## PROFESSIONAL INSTALLATION GUARANTEED

Quality of installation is just as important to long-term performance as manufacturing quality. A great new door or window that's poorly installed won't perform the way it should. That's why we were the first in Canada to train our installers using the Installation Masters™ certification program. Developed by the American Architectural Manufacturers Association, the program ensures that every installer used by ALL WEATHER WINDOWS RENOVATIONS has been trained in "best practices" to get the job done right.

### 5-YEAR INSTALLATION WARRANTY

You can rest assured you'll get proper, professional installation, backed by our 5-year warranty on installation labour.

INSTALLATION™  
*Masters*



### HERE'S HOW THE INSTALLATION PROCESS WORKS:

1. Your order information is processed by an ALL WEATHER WINDOWS RENOVATIONS representative and submitted to our customer service team.
2. Within a few weeks, one of our installation specialists will contact you to schedule a final measurement at your home to make sure everything fits perfectly.
3. The final measurements are submitted and the manufacturing process begins. Your new doors or windows will typically be custom built in 3 - 4 weeks. Note: lead times may vary depending on product chosen.
4. We'll call you to confirm an installation date about 2 weeks in advance, and remind you to remove your blinds and any other items that might be in the way, and to clear a 4-foot space around the inside and outside of the windows for ease of access. You'll also need to cover items that may get dusty from the installation process.
5. If you are having a door space enlarged, please make sure all electrical is relocated by an electrician prior to the installation date.
6. Installation will typically begin in the morning. Payment will be required upon completion. If you won't be home at the time of completion, the balance owing or signed certificate should be given to the installers when they arrive.



### TYPES OF INSTALLATION:

With renovations, we offer two types of installation finishes depending on the construction of your home.

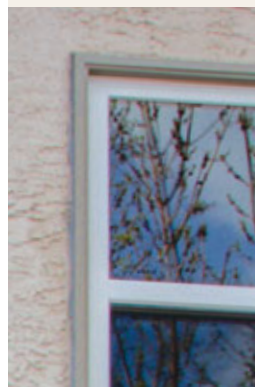

#### BRICKMOULD

Our EnergySaver and Magnum series can feature a factory applied PVC brickmould in multiple color options and a 2" or 1 1/2" width, and is ideal for the replacement of old wood windows that have an existing wood exterior brickmould and sill.

#### BLOCK AND CAP

Need custom colours or a larger trim to seal an existing window opening? Block and Cap is the solution, providing a completely prefinished exterior with a variety of width and color options.

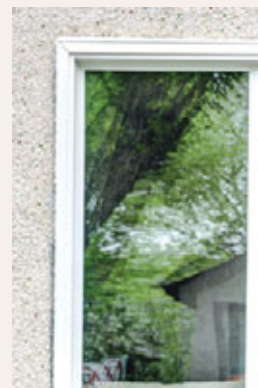



## BEAUTIFUL, TOP-QUALITY DOORS FOR YOUR RENOVATION

### STEP UP TO A BEAUTIFUL ENTRANCE.

Your front door says a lot about who you are and can improve the entire appearance of your home. Use your front door to make a bold statement, create a sense of understated elegance, or simply offer a warm welcome. ALL WEATHER WINDOWS RENOVATIONS has a door to suit your style.

Choose from durable steel doors, wood grain-textured fiberglass, or attractive smooth fiberglass. Create a unique look by adding a doorlite or transom from our designer range. Add decorative glass combined with metal caming for a truly impressive effect.

For a truly one-of-a-kind look, ask your sales representative about custom painting your door before the installation to get a factory-finish look that is uniquely yours.

### LET THE OUTDOOR VISTAS IN, BUT NOT THE WEATHER.

The clean design and meticulous engineering of our patio doors dramatically enhance any room. Patio doors open up a space, expand your view and help bring the beauty of the outdoors in. Choose from two popular styles: French or Sliding.

Garden doors add comfort and elegance to your home. Choose single opening doors or double doors with one fixed panel. All our doors can be configured to suit your home.

No matter which door you choose, you'll get a door that's ENERGY STAR® rated for superior energy efficiency, and built to last.

Ask about our  
**NAFS DOOR SYSTEM**  
which meets the  
North American  
Fenestration Standard

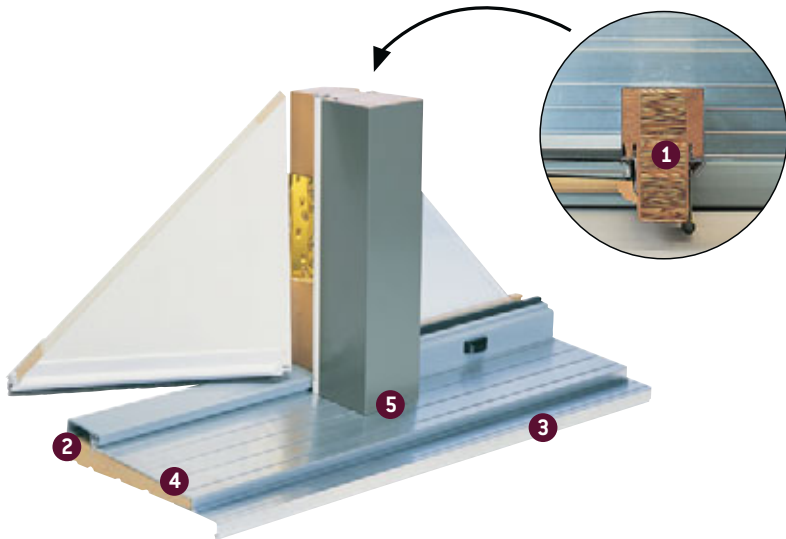

- 2" cladding gives your front entrance a wider, more classic appearance.
- Designer transom tops off your door and brightens your front entrance.

**ONE PIECE DOOR SILL FEATURES**

- 1 Engineered laminated woodposts give improved strength and are warp resistant
- 2 Full sill blocking
- 3 Drip lip
- 4 One piece sill design
- 5 Non-wicking neoprene gaskets used at all joinery; no caulking is used

**DOOR SWEEP FEATURES**

- Best in the industry. Lasts longer, operates smoother, and seals out moisture better than any other.
- Each fin seal is made with a clear centre pile, which prolongs the lifespan of the seal while providing better protection against the elements.
- Features a built-in drip lip, internal water dam with drain hole, and gasket seals, unique to the All Weather Windows sweep.



- 1 Gasket sealed on both sides
- 2 Water dam
- 3 Triple fin seals
- 4 Drip lip
- 5 Built-in drain hole

# DOORS: A STEP-BY-STEP BUYING GUIDE

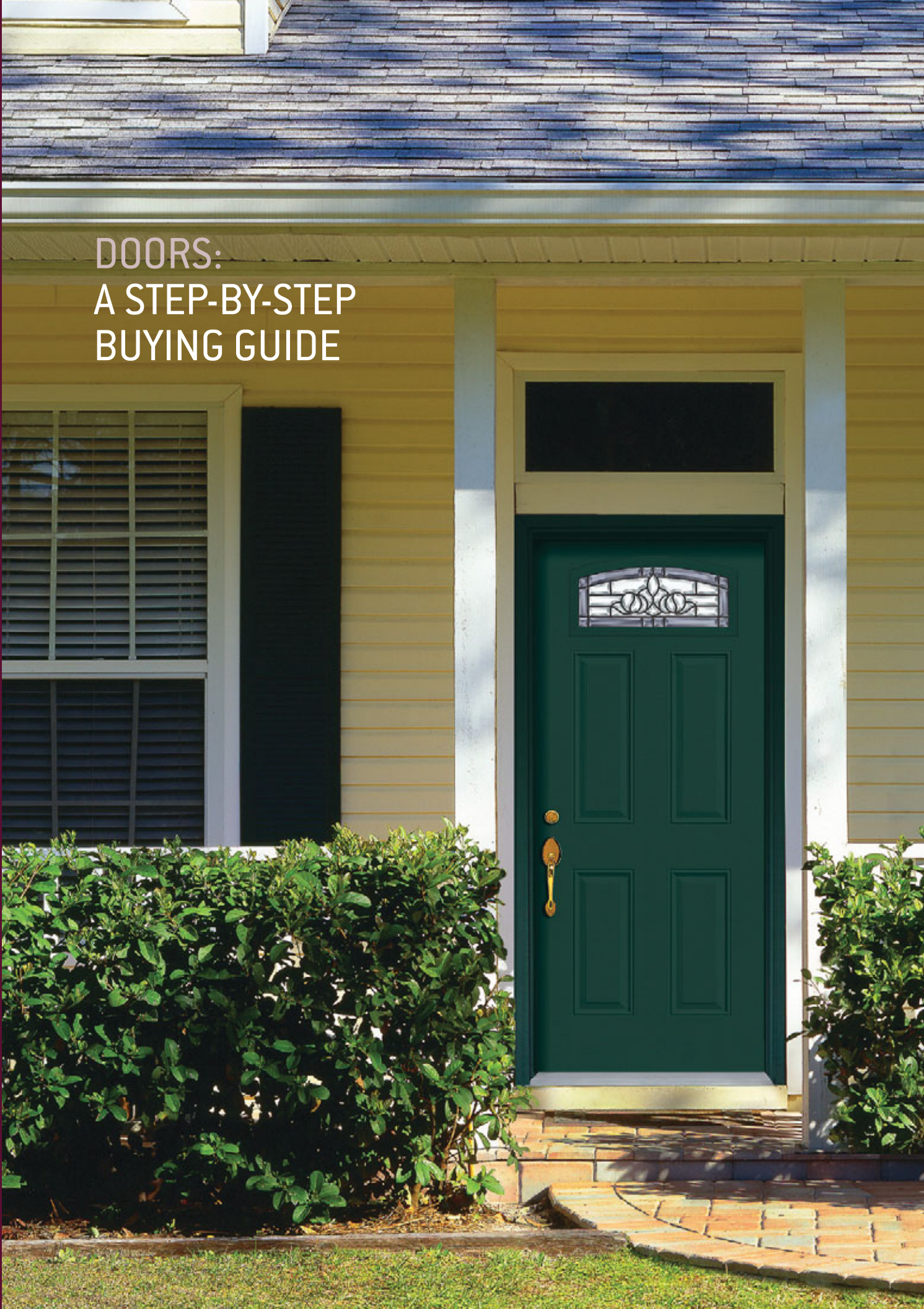

Nothing adds greater curb appeal to your renovation than a new entrance, so you'll want to choose your door carefully. ALL WEATHER WINDOWS RENOVATIONS has a wide choice of styles, designs and materials to choose from, and our representatives will be happy to help you select the doors that are ideally suited to your renovation.

To choose the doors that deliver the appearance and performance you want, keep these three basic steps in mind as you explore pages 14-27:

#### STEP 1: CHOOSE YOUR DOOR STYLE.

Bold or subtle? Traditional or contemporary? Solid door with decorative windows? Does the door match your house and the new look you're trying to achieve with your renovation?

#### STEP 2: CHOOSE YOUR MATERIAL.

For a front entry door, consider a wood grain-textured fiberglass that gives you the refined look of real wood -- without the upkeep. Go clean, solid and classic with high-definition steel, or choose a smooth fiberglass that can be painted to any colour you desire. For patio and garden doors, choose the durability of PVC or get beauty and strength in warp resistant, engineered wood.

#### STEP 3: CHOOSE YOUR OPTIONS.

Dress up your door with imaginative custom options such as sidelites, designer transoms and decorative glass inserts. Add matching colour to the brickmould or cladding. Finish it off with grilles, caming, and designer hardware.

For further assistance, talk to your All Weather Windows Renovations Sales Representative. Visit [awwreno.com](http://awwreno.com)

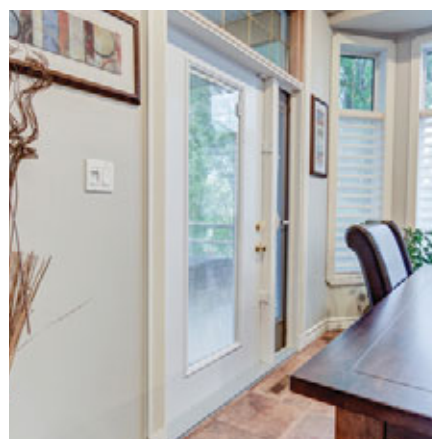



## VERSAILLES FRENCH DOORS

### METAL CLAD WOOD

The Versailles French door combines classic looks with superior performance and functionality, offering the most light from a hinged door. This door offers a durable metal clad exterior that is available in our 9 standard colours. Its silky smooth, premium softwood interior is a natural canvas for stains, paints, and varnishes.

Engineered wood technology and laminated veneer lumber provide exceptional protection against warping. Our multi-point locking system comes standard for your security and convenience.

The Versailles French door comes in numerous in-swing/out-swing operating combinations, as well as venting options. They can be installed in configurations up to four wide.

Ask about our  
**NAFS DOOR  
SYSTEM**

which meets the  
North American  
Fenestration Standard

#### FEATURES:

- Elegant Euro-style
- Classic wood interior, durable metal clad exterior
- Engineered wood to resist warping
- Choice of in-swing/out-swing combinations
- Multi-point locking system



**VERSAILLES FEATURES:**

- 1** Aluminum clad exterior for durability
- 2** Engineered wood posts eliminates warping and adds strength
- 3** One piece door sill



**TIP**

Use a single Versailles door as a front entry door to let natural light in!

**HARDWARE OPTIONS**



Polished Brass



Brushed Nickel



Oil-Rubbed Bronze

Our doors come with multi-point locking systems to ensure a tight, secure seal by locking the door in three places with one turn of a knob.

*\* For exterior colour, grille and SDL options, see pages 50-53.*



# WEATHERGARD SLIDING PATIO DOOR

## METAL CLAD WOOD

Our WeatherGard sliding patio door features an array of innovative design elements, such as a unique hybrid frame. The interior side of the frame is made of profiled premium softwood for aesthetic beauty, the exterior is a durable metal clad for high performance without maintenance, and a welded PVC frame is in between – providing superior insulation.

Only the finest materials are used, such as premium hemlock on the interior that can be finished to suit your personal style. The durable metal clad exterior is available in 9 standard colours or over 50 premium colours. What’s more, a protective PVC liner between the wood and the metal cladding prevents wood against rot caused by moisture, an important consideration that is not offered by some other manufacturers.

Other superior features include a full 1 3/4” thick laminated veneer lumber-style slab, a one-piece 7” bottom rail using fusion layered technology, stainless steel rollers and multi-point locking system. Our signature series hardware features a contour shape and is available in a selection of finishes to suit your style.

### FEATURES:

- Innovative hybrid frame
- Premium hemlock interior
- PVC liner to protect wood from moisture
- Metal clad exterior in over 50 colours
- Stainless steel rollers
- Secure stainless steel multi-point locking system

PERFORMANCE				
	Air Infiltration	Water Penetration	Wind Load	Forced Entry
WeatherGard Sliding Patio Door	A3	B3	C3	F2

NOTE: Testing is done to A4400-00 standards. Testing results are for single windows with no grilles. Ratings higher than A3, B3, C3 must be specified at time of order.

### HARDWARE OPTIONS

#### Standard



Black (Exterior)



Beige (Interior)

#### Optional



Brushed Nickel

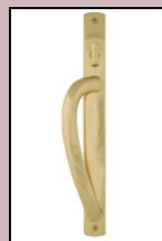

Polished Brass



Oil Rubbed Bronze

Our signature series hardware features a contour shape which is both elegant in style and easy to grasp. Our WeatherGard patio doors come standard with Beige interior and Black exterior signature hardware. Optional hardware finishes Brushed Nickel, Polished Brass and Oil Rubbed Bronze are also available.

\*For exterior colour, grille and SDL options, see pages 50-53.



# EVEREST SLIDING PATIO DOOR

PVC

The Everest provides maintenance-free, long lasting operation for years to come.

### FEATURES:

- Fingertip-smooth operation
- Lifetime warranty on rollers
- Reinforced to prevent drafts
- Slimline or wide brickmould
- Foot lock and keyed lock option available

### INTERIOR COLOURS



White

Wicker

### EXTERIOR COLOURS



White

Wicker

Architectural Brown

Black

Canyon Clay



Chocolate Brown

Sable

Clear Anodized

Pebble

\*Colours may not be exactly as shown.



Optional keyed lock



Optional foot lock

PERFORMANCE		
	Air Infiltration	Water Penetration
Everest Patio Door	A3	B4
	Wind Load	Forced Entry
	C3	F10

NOTE: Testing is done to A4400-00 standards. Testing results are for double slider with no grilles. Ratings higher than A3, B3, C3 must be specified at time of order.

\* For grille options see page 53.

# ELEMENT SLIDING PATIO DOOR

PVC/METAL CLAD

This combination pvc/metal clad patio door is the perfect complement to our Apex Alloy windows.



## FEATURES:

- PVC interior with extruded aluminum exterior
- Steel reinforced vertical stiles
- Double protection sill with seamless PVC capping
- Optional aluminum brickmould



	PERFORMANCE			
	Air Infiltration	Water Penetration	Wind Load	Forced Entry
Element Sliding Patio Door	A3	B4	C3	F2

NOTE: Testing is done to A4400-00 standards. Testing results are for double slider with no grilles. Ratings higher than A3, B3, C3 must be specified at time of order.



Ask about our  
**NAFS DOOR  
SYSTEM**  
which meets the  
North American  
Fenestration Standard

# STRONG ARM II GARDEN DOORS

## STEEL AND FIBERGLASS

A stylish upgrade from traditional sliding patio doors, our renovation garden doors combine European-inspired looks with greater security and a zero maintenance exterior.

Garden doors are available in configurations from one-to four-wide, with one panel opening as a door and the second panel opening window style (swing out only) or fixed.

All joinery is gasket sealed to protect against the elements outside; no caulking is used. Our engineered laminated wood posts offer superior strength and eliminate warping. Metal cladding on the door post and jambs is available in 9 standard colours. Internal blinds are available in White or Almond.

**PLUS** – ask about our optional renovation garden door, specially sized to replace an existing 5' or 6' sliding door (not shown) without having to structurally alter your home.

### EXTERIOR COLOURS

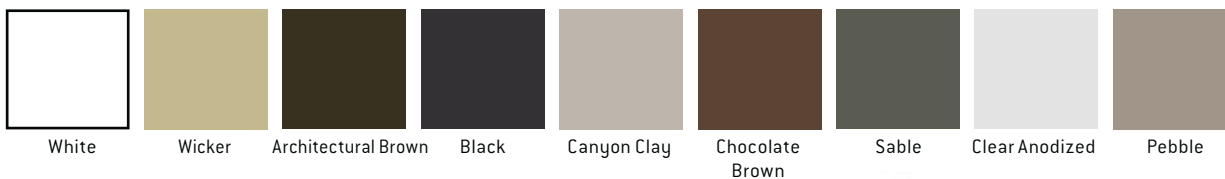

\*Colours may not be exactly as shown.



### FEATURES:

- 1 Engineered wood post for exceptional strength
- 2 Gasket sealed joinery
- 3 One piece door sill
- 4 Fixed or venting panel
- 5 Built-in drip lip



\* For brickmould and grille options, see page 50-53.



## STRONG ARM II ENTRY DOORS

### STEEL AND FIBERGLASS

Strong Arm II doors offer more than just good looks. They are built to withstand whatever Mother Nature can throw at them. Seams and joinery on our doors are sealed with gaskets instead of messy caulking that can break down over time. Our posts are made from manufactured wood to give extra strength and to eliminate warping.

Our superior, one-piece door sill prevents the leaks that can develop with ordinary doors that feature a two-piece sill. In addition, our new sill features an innovative drip lip to protect the area under the sill by forcing water away.

Strong Arm II door frames incorporate a common frame construction with multi-combination post, resulting in a stronger, more versatile frame. Metal cladding on door posts and jambs are available in 9 standard colours. Consider combing these doors with a decorative glass lite from our wide selection to add an elegant touch of style and more incoming light.

#### FEATURES:

- Durable gasket seals
- Warp-resistant posts
- One-piece sill prevents leaks
- Metal cladding on posts available in 9 colours



Ask about our  
**NAFS DOOR SYSTEM**  
 which meets the  
 North American  
 Fenestration Standard

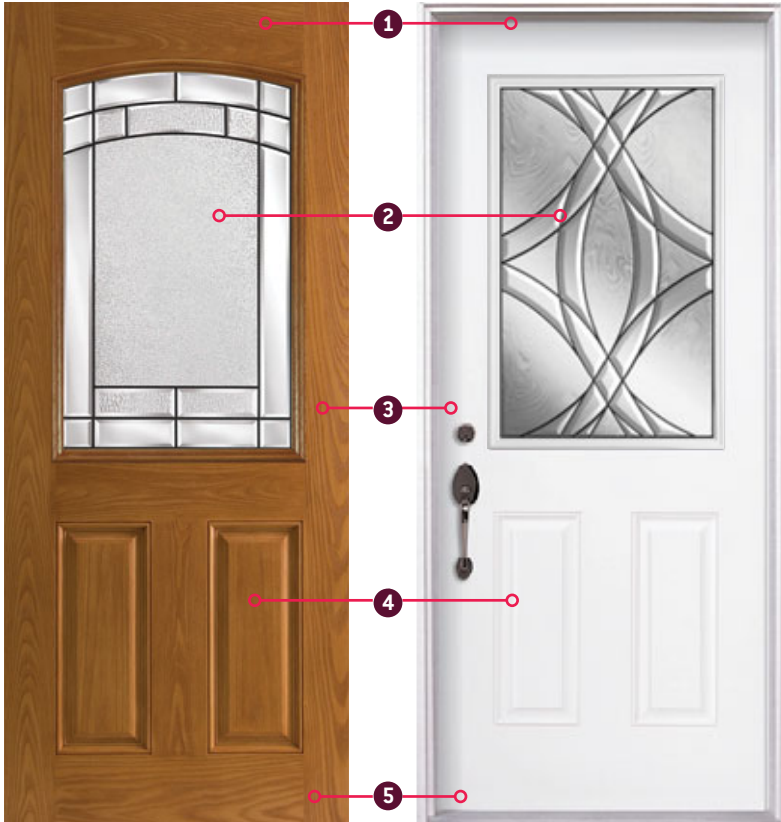

Textured Fiberglass

Smooth Fiberglass

## FIBERGLASS DOORS

### 1. High Performance Fiberglass Facings

Specially engineered fiberglass facings provide maximum protection and durability. Fiberglass is dent resistant and resists splitting, cracking and warping.

### 2. Glass Inserts

All decorative glass inserts feature a triple pane 1" insulated assembly. Double pane insulated inserts and flush-glazed frame designs are also available.

### 3. Engineered Stiles

Hinge and lock stiles feature laminated lumber providing excellent dimensional stability.

### 4. Polyurethane Core

Rigid polyurethane foam, meeting strict environmental guidelines, provides maximum thermal protection and dimensional stability.

### 5. Rot-Resistant Bottom Rail

A high-performance, composite material is utilized on all bottom rails, giving excellent rot-resistance.



#### INTERNAL BLOCKING

Lock area is reinforced with a block providing a solid mounting surface.



#### TRUE SQUARE-EDGE DESIGN

The square-edge design of fiberglass offers an attractive wood door appearance and permits easy field matching.



#### DEEP WOOD GRAIN TEXTURE

The unique deep wood grain texture yields a very realistic wood-like appearance and allows for easy finishing.



#### ENHANCED STAINABILITY

While wood requires a multi-coat staining or painting process, a fiberglass door will take a significantly shorter period of time to stain.

# OUR COMPLETE ENTRY DOOR LINE



The Barrington Fiberglass door collection defines a new level of luxury in fiberglass entry systems. Barrington's distinct raised moulding and outstanding wood grain texture, reminiscent of hand-crafted hardwood doors, impart unbelievable warmth and elegance to any home.

All Barrington doors are factory-glazed with a stunning, proprietary collection of specialty decorative glass. By combining dramatic decorative glass with impressive raised moulding and detailed wood-grain texture, our Barrington Door Collection presents a new dimension of luxury in fiberglass entry doors.

## Colours

Standard Brickmould & Jamb Wrap Colours



Consult [awwreno.com](http://awwreno.com) for exclusive premium colour selection.

Colours shown are approximate. Due to printing limitations, actual colours may vary slightly.



AvantGuard™ Black Walnut/AvantGuard™ Spanish Cedar finishes



Flagstaff™ Plank AvantGuard™ Black Walnut/AvantGuard™ Spanish Cedar finishes



Flagstaff™ Plank (stainable)



Sierra™ Camber Top Plank/Sierra™ Camber Top (stainable)



Craftsman Oak/Craftsman Mahogany (stainable)



Barrington™ Oak / a (stainable)

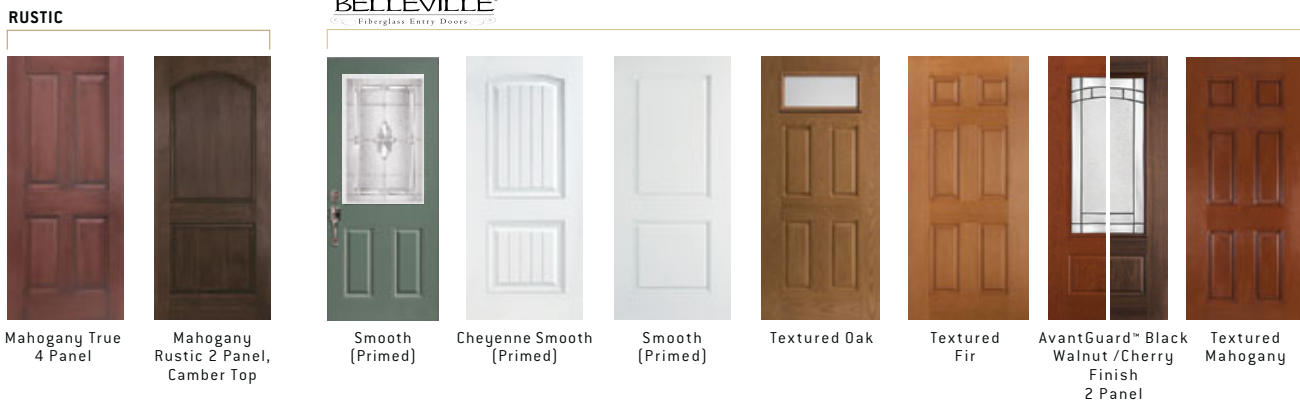

TRUE WHITE OAK



True White Oak (Pre-finished)

HIGH DEFINITION STEEL

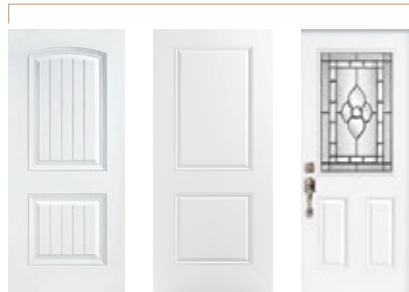

High Definition Smooth (Primed)  
High Definition Smooth Square Top (Primed)  
Sta-Tru® High Definition Smooth (Pre-finished)

CRAFTSMAN SMOOTH SKIN



Craftsman Smooth (Primed)

		SURFACE		DESIGN SIZE		PANEL MOULDING		GLAZING	
DOOR INDEX	Textured Fiberglass	AvantGuard™ (Prefinish)	<ul style="list-style-type: none"> <li>• Prefinished authentic hardwood texture</li> <li>• Available in the AvantGuard™ Black Walnut &amp; Spanish Cedar texture</li> </ul>	<ul style="list-style-type: none"> <li>• Available in 6'8" &amp; 8'0" heights, plus 3'6" widths in 8'0" heights</li> </ul>	<ul style="list-style-type: none"> <li>• Classic wide profile creating a distinctive heirloom quality design</li> </ul>	<ul style="list-style-type: none"> <li>• Factory-glazed sidelite with one proprietary decorative glass or clear insulated glass</li> </ul>			
		Sierra™ Mahogany	<ul style="list-style-type: none"> <li>• Stainable authentic Mahogany texture in a planked or non-planked profile</li> </ul>	<ul style="list-style-type: none"> <li>• Extensive collection of unique designs, 6'8" &amp; 8'0" heights, plus 3'6" widths available in 8'0" heights</li> </ul>	<ul style="list-style-type: none"> <li>• Beautiful raised moulding integrated into the facing, no plant-on applique</li> </ul>	<ul style="list-style-type: none"> <li>• Factory-glazed sidelites with proprietary, decorative glass</li> <li>• Architecturally correct alignment between glazing frame &amp; panel moulding in three styles</li> </ul>			
		Flagstaff™	<ul style="list-style-type: none"> <li>• Stainable authentic Mahogany texture in a classic plank door design with contemporary styling</li> </ul>	<ul style="list-style-type: none"> <li>• Available in 6'8" &amp; 8'0" heights, plus 3'6" widths in 8'0" heights</li> </ul>	<ul style="list-style-type: none"> <li>• Vertical plank design featuring clean lines</li> </ul>	<ul style="list-style-type: none"> <li>• Factory-glazed sidelites with proprietary, decorative glass</li> <li>• Architecturally correct alignment between glazing frame &amp; panel moulding in three styles</li> </ul>			
		Craftsman	<ul style="list-style-type: none"> <li>• Stainable straight-grain hardwood, Oak texture and authentic hardwood Mahogany texture</li> </ul>	<ul style="list-style-type: none"> <li>• Available in 3'0" x 6'8"</li> </ul>	<ul style="list-style-type: none"> <li>• Mission or Craftsman style with three recessed panels</li> </ul>	<ul style="list-style-type: none"> <li>• Factory-glazed with custom glazing system with three options including clear</li> </ul>			
	Rustic	<ul style="list-style-type: none"> <li>• Deep graining and distinct plank detail of true distressed wood</li> </ul>	<ul style="list-style-type: none"> <li>• Available in 3'0" x 6'8"</li> </ul>	<ul style="list-style-type: none"> <li>• Panel profiles with a distinctly European architectural style</li> </ul>	<ul style="list-style-type: none"> <li>• Compatible with our full line of Glass glazing inserts, architecturally correct stile and rail proportions</li> </ul>				
	Pre-finished White Oak	True White Oak	<ul style="list-style-type: none"> <li>• Pre-finished in UV protected White Oak wood-grain finish</li> </ul>	<ul style="list-style-type: none"> <li>• Available in 6'8" designs</li> </ul>	<ul style="list-style-type: none"> <li>• Traditional recessed panels</li> </ul>	<ul style="list-style-type: none"> <li>• Compatible with our full line of Glass inserts</li> </ul>			
	Belleville®	N/A	<ul style="list-style-type: none"> <li>• Traditional oak, fir &amp; ribbon-stripped mahogany with variable-depth woodgrain</li> </ul>	<ul style="list-style-type: none"> <li>• Available in 3'6" x 6'8"</li> </ul>	<ul style="list-style-type: none"> <li>• Panel profiles with a distinctly European architectural style</li> </ul>	<ul style="list-style-type: none"> <li>• Over 100 customizable door and glass designs</li> </ul>			
Belleville® AvantGuard	AvantGuard™ (Prefinish)	<ul style="list-style-type: none"> <li>• Pre-finished in Black Walnut &amp; Cherry</li> </ul>	<ul style="list-style-type: none"> <li>• Available in 3'6" x 6'8"</li> </ul>	<ul style="list-style-type: none"> <li>• Panel profiles with a distinctly European architectural style</li> </ul>	<ul style="list-style-type: none"> <li>• Alston, Element, Sierra, Clear</li> </ul>				
Doorlites for wood grain textured fiberglass are available with stainable frames.									
DOOR INDEX	Smooth Fiberglass	Belleville® Cheyenne Smooth	<ul style="list-style-type: none"> <li>• Paintable smooth skin finish</li> </ul>	<ul style="list-style-type: none"> <li>• Available in 6'8" &amp; 8'0" designs</li> </ul>	<ul style="list-style-type: none"> <li>• Unique sticking and beaded panel design</li> </ul>	<ul style="list-style-type: none"> <li>• Compatible with our full line of Glass inserts</li> </ul>			
		Belleville® Smooth	<ul style="list-style-type: none"> <li>• Paintable smooth skin finish</li> </ul>	<ul style="list-style-type: none"> <li>• Exclusive collection of both Smooth &amp; Textured designs; both traditional &amp; unique; 6'8" &amp; 8'0" heights available</li> </ul>	<ul style="list-style-type: none"> <li>• High Definition panel profile</li> </ul>	<ul style="list-style-type: none"> <li>• Compatible with our full line of Glass inserts</li> </ul>			
	Craftsman Smooth Skin	<ul style="list-style-type: none"> <li>• Paintable smooth skin surface</li> </ul>	<ul style="list-style-type: none"> <li>• Available in 6'8" &amp; 8'0" designs</li> </ul>	<ul style="list-style-type: none"> <li>• Premium high definition recessed panels</li> </ul>	<ul style="list-style-type: none"> <li>• Available in 3 factory flush-glazed glass inserts: Metropolis, Spring &amp; Clear</li> <li>• Clear glass comes with a selection of internal grille or external SDLs</li> </ul>				
DOOR INDEX	Steel	HD	<ul style="list-style-type: none"> <li>• Paintable smooth skin finish</li> </ul>	<ul style="list-style-type: none"> <li>• Available in 6'8" designs</li> </ul>	<ul style="list-style-type: none"> <li>• High Definition panel profile</li> </ul>	<ul style="list-style-type: none"> <li>• Compatible with our full line of Glass inserts</li> </ul>			
		Sta-Tru® HD	<ul style="list-style-type: none"> <li>• Prefinished white smooth surface</li> </ul>	<ul style="list-style-type: none"> <li>• Available in 6'8" designs</li> </ul>	<ul style="list-style-type: none"> <li>• High Definition panel profile</li> </ul>	<ul style="list-style-type: none"> <li>• Compatible with our full line of Glass inserts</li> </ul>			

\* Doors come unstained/unpainted except for AvantGuard™ finishes, True White Oak & Sta-Tru® HD Steel.

# ENTRY DOOR DECORATIVE GLASS



Adelaide



Alys



Aria



Attraction



Aurora



Cachet

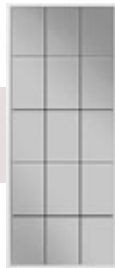

Centennial



Chelsea



Chord



Cuzco



Element



Evangeline II



Everton



Frameview

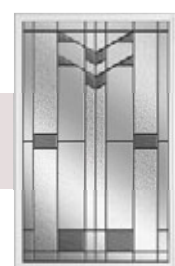

Frontier

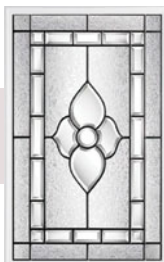

Georgian



Gloria



Harlow



Kallima



Kordella



Marco



Marquise

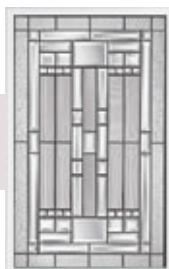

Naples



Panama



Pear



Royston

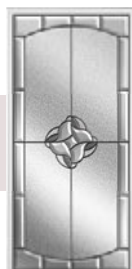

Rozet

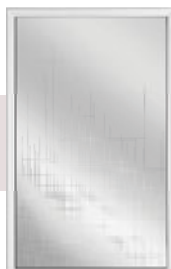

Sketch



Sonnet

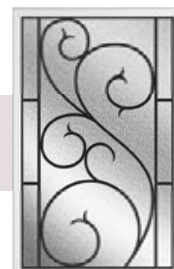

Tanglewood

SILK SCREEN DECORATIVE DOOR LITES

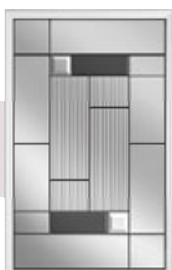

Vignette



Waterton

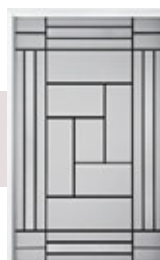

Louisbourg

# WINDOWS: A STEP-BY-STEP BUYING GUIDE





Installing new windows in your home is a considerable investment of time and money, so you want to make the right choices. In the following pages you'll find helpful tips from the experts at ALL WEATHER WINDOWS RENOVATIONS to help you select the products that are best suited to your renovation.

There are two main considerations:

**Appearance.** Do your windows capture the look you wish to project?

Do they suit the style of your house? Do they open and close the way you prefer?

**Performance.** Are the windows rated for the climate zone in which you live? Do they suit the angle and amount of sun exposure your house enjoys? Do they have high ratings for energy efficiency and weather resistance? Are they designed for the Western Canadian weather?

To choose the windows that deliver the appearance and performance you want, follow these three basic steps, as outlined on pages 30-38:

**Step 1:** Choose your style

**Step 2:** Choose your frame material

**Step 3:** Choose your glass



For further assistance, talk to your All Weather Windows Renovations Sales Representative. Visit [awwreno.com](http://awwreno.com)

## STEP 1: CHOOSE YOUR STYLE

You probably know the size of windows you need, and your preferred aesthetic look. Next, consider the operating style.

Operating style – or how your windows open and close – also has an effect on energy efficiency. Generally a fixed or picture window offer the most efficiency as they don't open. The more severe your local climate, the better the performance you'll need from your windows.

For further assistance, talk to your All Weather Windows Renovations Sales Representative. Visit [awwreno.com](http://awwreno.com)







**FIXED**

A fixed window is basically a casement or awning window that doesn't open, but offers energy efficiency.

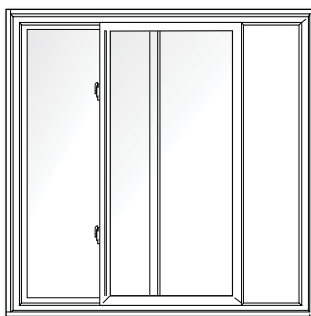

**SLIDER**

The Slider window has one or more sashes that slides open horizontally.



**PICTURE**

Picture windows do not open. They offer a low-profile frame to maximize glass surface, allowing a beautifully clear, unobstructed view.

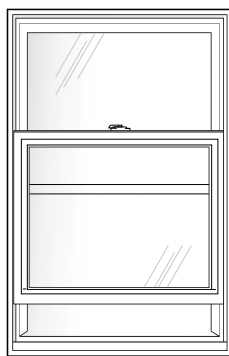

**SINGLE HUNG**

With a bottom sash that slides up, the single hung window allows controlled airflow into your home.



**CASEMENT**

Hinged on the side, casement windows swing outward like a door, providing excellent air circulation into your home. They are also one of the most energy efficient operating windows because of their tight seal when closed.



**AWNING**

An awning window is a casement window that is hung horizontally. Hinged on top, it swings outward, shielding from the rain while providing good ventilation and constant airflow. Like the casement window, it is also one of the most energy efficient operating windows.



**BAY & BOW**

Bay and bow windows allow you to expand an area in your home. Made up of a combination of windows attached at an angle, these windows extend beyond the wall, opening up any room.

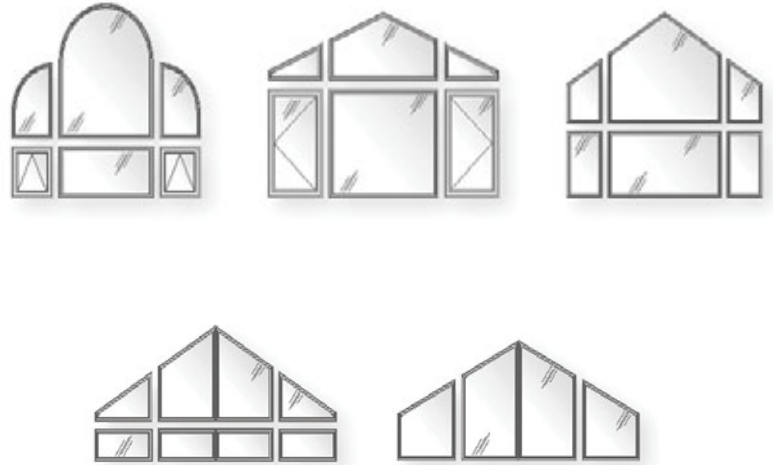

### CUSTOM STYLES

We can help you use a unique combination of windows to create a distinctive look for your home. These and other custom options are available. Talk with your ALL WEATHER WINDOWS RENOVATIONS sales representative to discuss your ideas.

### ACRYLIC BLOCKS

Ideal for bathrooms and front entrances, acrylic block windows ensure privacy while letting in light, and are ideal for bathrooms and entrances. They can be constructed in various sizes using 6-inch or 8-inch blocks to form squares or rectangles.



### BLOCK COMBINATIONS

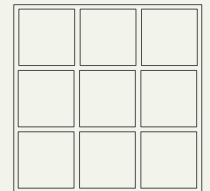
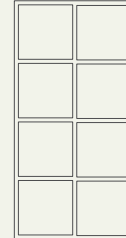
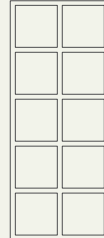
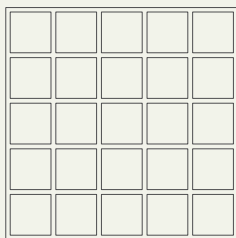

## STEP 2: CHOOSE YOUR FRAME MATERIAL

ALL WEATHER WINDOWS RENOVATIONS offers a choice of frame materials that deliver excellent value, all-weather durability, solid performance and low maintenance, so you'll get extra long-term value from your renovation. A wide selection of options let you personalize windows that are unique to your home.

### PVC

Our virgin PVC (Polyvinyl Chloride) windows are energy efficient, durable, and resistant to moisture and corrosion. This type of frame also reduces heat loss, while insulating sound, ensuring an energy efficient, quietly comfortable home. Plus they're virtually maintenance free, with no need to paint, stain or refinish. Learn more and see our full PVC line starting on page 42.

---

Price Range: \$ - \$\$\$

---

### METAL CLAD PVC

Create a statement by upgrading from PVC to our award-winning metal clad PVC windows. With bold styling and a variety of exterior colour choices, these windows combine the strength and elegance of aluminum cladding with all the benefits of a fusion-welded PVC frame. The result is superior durability and energy efficiency. And just like our PVC windows, they're virtually maintenance free and made with virgin PVC. Get full details about our metal clad PVC lineup starting on page 39.

---

Price Range: \$\$ - \$\$\$\$

---

\*Price range may vary, depending on options.



## STEP 3: CHOOSE YOUR GLASS

Glass is the single most important factor affecting the energy efficiency of your windows. Choose glass that suits the weather conditions where you live. Colder climates will require the extra insulating properties of special glass coatings.





**GLASS OPTION RATINGS:**

GLASS NAME	HEAT SYSTEM	DESCRIPTION	METRIC*		IMPERIAL*			VISIBLE LIGHT	UV BLOCK
			U-VALUE	R-VALUE	U-VALUE	R-VALUE	SHGC		
CLEAR	DUAL	Dual pane, clear glass, no coatings	2.725	0.367	0.480	2.084	0.760	81%	42%
	TRI	Triple pane, clear glass, no coatings	1.760	0.568	0.310	3.226	0.685	74%	52%
LOW-E 	HS1-C180	Dual pane, one Low-E coating, Argon	1.476	0.678	0.260	3.847	0.685	79%	71%
	HS2-C180	Triple pane, one Low-E coating, Argon	1.045	0.957	0.184	5.433	0.615	73%	76%
	HS3-C180	Triple pane, two Low-E coatings, Argon	0.755	1.325	0.133	7.521	0.560	70%	87%
SUNSTOP 	HS4-C270	Dual pane, one SunStop coating, Argon	1.408	0.710	0.248	4.033	0.367	70%	86%
	HS5-C270	Triple pane, one SunStop coating, Argon	1.056	0.947	0.186	5.377	0.338	63%	88%
	HS6-C270	Triple pane, two SunStop coatings, Argon	0.704	1.420	0.124	8.065	0.310	54%	96%
SYSTEM V 	HS1V-C180/i89	Dual pane, two Low-E coatings, Argon	1.187	0.842	0.209	4.783	0.623	77%	73%
	HS4V-C270/i89	Dual pane, one Low-E & one SunStop coating, Argon	1.136	0.880	0.200	4.998	0.361	69%	86%

\*Values are from centre of glass based on 3mm thickness.

\*Rating may vary by product line. See your sales representative for more details. All performance is C.O.G. (center of glass) rating based on vision 4.0 simulations. All C.O.G. R-values are based on ASHREA Winter Conditions.

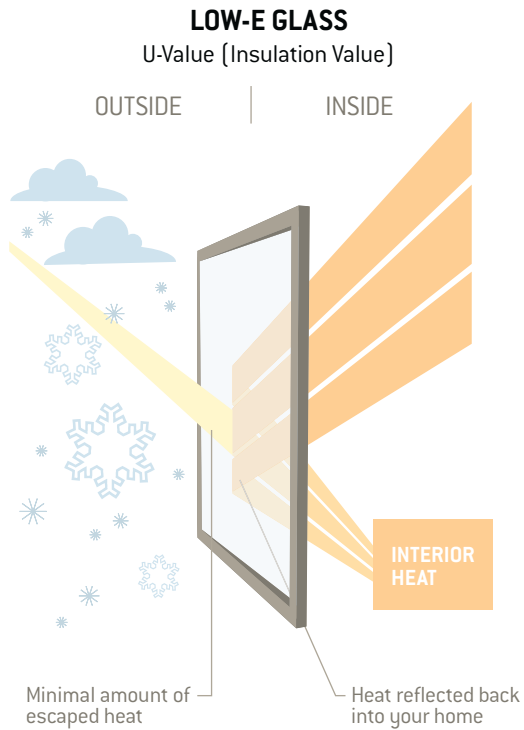

**SUNSTOP GLASS**  
Solar Heat Gain Coefficient (SHGC)

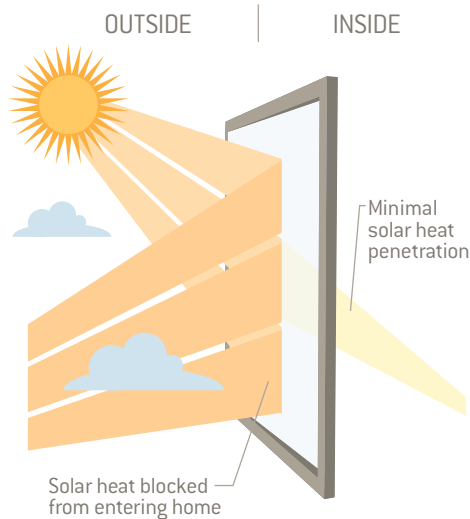

**DUAL PANE**

These windows have two panes of glass with no special coating applied. The dual panes of glass are spaced 1/2 inch apart, and the air between the panes acts as an insulation barrier, making your windows more energy efficient.

**ARGON GAS**

Argon gas is an inert gas—non-toxic, clear and odourless. Used to fill the space between panes of glass, argon gas minimizes convective currents that occur between glass panes. This reduces the tendency for glass to collect frost on cold winter days and improves the insulation quality of your windows.

**LOW-E**

Applied to the glass surface, Low-E (low emissivity) is a clear coating that reduces heat loss by reflecting furnace (or radiant) heat back into your home. It also allows a large percentage of outside solar energy to pass through the glass into your home. This coating is most beneficial in the winter, since the heat provided by the sun can reduce the demands on your furnace. When combined with dual or triple pane glass, Low-E can offer between 35%-105% better insulating values than non Low-E glass. No other coating has a greater impact on reducing heating bills and improving the overall comfort of a home.

**TRIPLE PANE**

A step up from dual pane is triple pane glass. Each pane of glass is spaced 1/2 inch apart creating two distinct air spaces. These three panes of glass provide more insulation than dual pane when it comes to energy efficiency. It also acts as an excellent sound barrier, giving your home added privacy.

**SYSTEM V**

Innovative System V is the most energy efficient dual pane windows system on the market today. We start with the most advanced glass available and add Low-E coatings on not one but two glass surfaces – the inside surface of the outer pane, and the outside surface of the inner pane. This gives you triple-glass performance in a dual pane window.

**SUNSTOP**

SunStop uses two layers of Low-E on the inside surface of the outer pane to block out the sun's heat, light and UV rays. Perfect for south and west facing windows, this coating keeps your home cool and comfortable in the summer to help reduce air conditioning costs. SunStop also improves the insulation properties of glass to help keep your home warmer in the winter.

## R-VALUE:

A measure of the resistance of heat transfer through glass. The higher the R-Value, the better the window insulates against incoming solar heat. This is ideal for keeping your home cooler in summer if some walls of your home have a lot of exposure to hot sun.

## SOLAR HEAT GAIN:

The amount of the sun's heat transfer through glass from the exterior to the interior. The higher the solar heat gain, the more a window allows heat to pass through into a home. This helps you benefit from the sun's warming effect in winter.

## U-VALUE:

A measure of the rate of non-solar heat flow, i.e., the heat inside your home created by your furnace, escaping through the glass. The lower the U-Value, the greater a window's resistance to interior heat loss and the better its insulating value, helping to keep your home warm in winter.

## SPACER BARS

There are two types of warm edge spacer bars used to create an insulated seal for your windows – foam spacers and stainless steel spacers. When looking at the ratings, it's important to look at the total rating of the window, not just the spacer bar. Both our foam and stainless steel spacers have undergone rigorous testing for thermal performance, volatile fog, seal durability, argon retention and shearing—and passed with flying colours. They demonstrate superior longevity and flexibility, ensuring long-term unit performance. This gives you the peace of mind knowing that your windows are performing at optimal levels. **PLUS** our black spacer bars don't draw your eye like silver or gray spacers so there is no disruption to your view – they are practically invisible!



# TEXTURED GLASS OPTIONS



REEDED CROSS



RAIN



GLUECHIP



REEDED NARROW



OPAQUE



PIN OBSCURE





## METAL CLAD

### PVC WINDOWS

Apex Alloy is our line of metal clad PVC windows, featuring high-performance, fusion-welded PVC frames that deliver improved energy efficiency and advanced structural integrity. Our revolutionary V-weld technology means a structurally superior design that virtually eliminates air and water leakage and makes combination windows more durable, efficient and reliable.

The triple weather stripping system and warm edge spacer enhance the energy efficiency and overall performance of the window design providing greater comfort in your home no matter what window style you choose. As with all our windows, you can rest easy knowing that they are guaranteed and under warranty. Apex Alloy uniquely combines an energy efficient frame with the durability of exterior aluminum cladding in a choice of over 50 exterior colours.



#### APEX ALLOY:

9950 Series Awning, Casement, Fixed, Picture



FUSION WELDED INSTEAD OF SCREWS VIRTUALLY ELIMINATES WATER LEAKS.

*Read more on Page 6*



Most Efficient  
**2015**

Les plus éconergétiques  
[energystar.nrcan.gc.ca](http://energystar.nrcan.gc.ca)



## APEX ALLOY 9950 SERIES

AWNING, CASEMENT, FIXED, PICTURE

The Apex Alloy window series, with revolutionary V-weld technology, virtually eliminates air and water leaks, for a warmer home and significant cost savings. A high performance fusion-welded PVC frame combines with the strength and durability of exterior aluminum cladding – available in over 50 colour choices to let you personalize the look and appeal of your home.

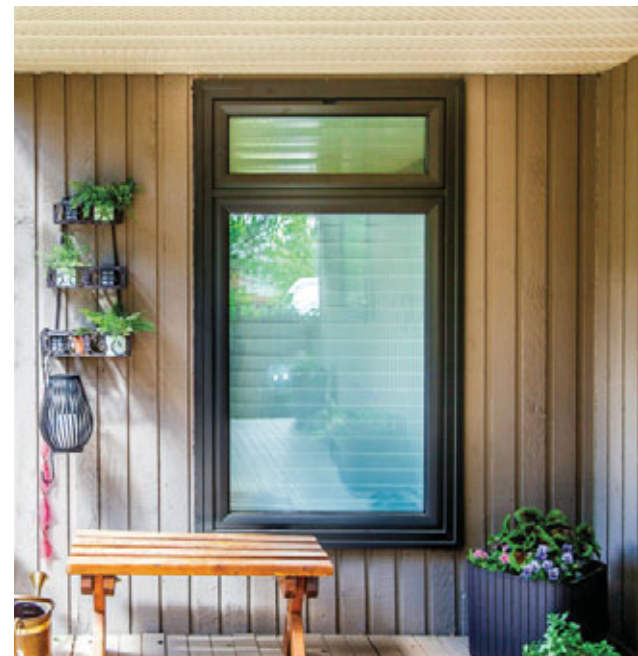

FUSION WELDED INSTEAD  
OF SCREWS VIRTUALLY  
ELIMINATES WATER LEAKS.

*Read more on Page 6*



**PRODUCT HIGHLIGHT: VIRTUALLY ELIMINATES AIR AND WATER LEAKS**



**FEATURES:**

- Fusion-welded PVC frame
- Clad in aluminum on the exterior for added durability and strength
- Cladding available in 50 colours
- 1.5" standard cladding. Also available with a 2" cladding

- 1 Gasket auto seal
- 2 Fusion welded frame for improved energy performance
- 3 2" Integral cladding

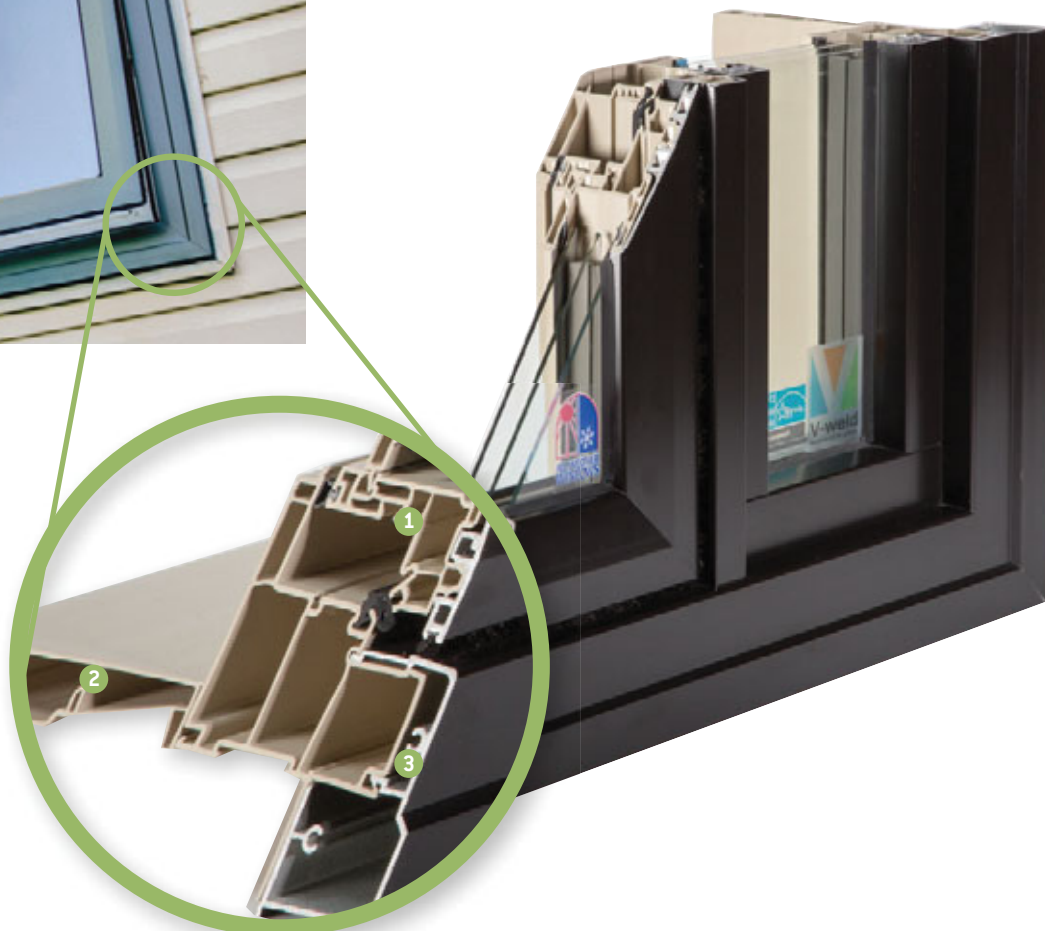

	PERFORMANCE			
	Air Infiltration	Water Penetration	Wind Load	Forced Entry
9950 Awning	A3	B7	C3	F20
9950 Casement	A3	B7	C3	F20
9950 Picture	Fixed	B7	C3	n/a
9950 Fixed Sash	A3	B7	C3	n/a

NOTE: Testing is done to A4400-00 standards. Testing results are for single windows with no grilles & clear dual glass. Ratings higher than A3, B3 & C3 must be specified at time of order.

## PVC WINDOWS

**ALL WEATHER WINDOWS RENOVATIONS** offers an extended line-up of PVC windows that present an attractive combination of energy efficiency, low maintenance, comfort and value. Innovative designs and unique features set our PVC windows apart. Set back glazing on many product series provides better structural strength and also improves thermal efficiency and water management by reducing window exposure.

An internal, sloped bridging design ensures water drains to the outside and our PVC drip lip forces water to drip straight down, away from your wall. Choose either a heavy framed individual box window system or an ingenious common mullion system that eliminates fasteners in the window frame's drainage path.



### PVC:

7000 Magnum Series Slider, Hung, Picture

2500 EnergySaver Series Awning, Bay and Bow, Casement, Fixed, Picture

9100 Apex Series Awning, Bay and Bow, Casement

9100 Apex Series with Renolit Awning, Bay and Bow, Casement, Fixed, Picture

6500 Titan Series Slider, Hung, Picture

Basement Series Double Slider, Hopper





## MAGNUM 7000 SERIES

SINGLE SLIDER, PICTURE, SINGLE HUNG

The beauty of Magnum windows is in what you see and what you don't see – a high performance design that is cost-effective and requires no maintenance.

The multiple brickmould colour options make this window an ideal choice for new construction or renovation, and allow you to mix and match Magnum windows with EnergySaver products in a uniform look.

An advanced sliding slider style that is superior to old types of sliders make it ideal for basements or other areas where casements or awnings could block foot traffic.

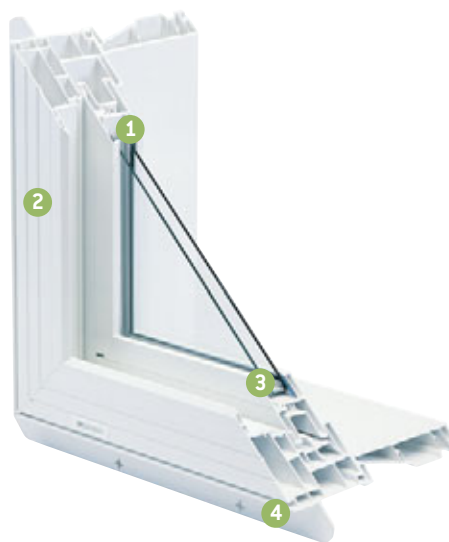

### WIDE PROFILE SLIDER FEATURES:

- 1 Adhesive glazing tape
- 2 Wide look for casement style appearance
- 3 Extruded PVC glazing stop
- 4 Integral nailing flange

	PERFORMANCE			
	Air Infiltration	Water Penetration	Wind Load	Forced Entry
7000 Single Slider	A3/Fixed	B3	C5	F20
7000 Single Hung	A3/Fixed	B3	C5	F10
7000 Picture	Fixed	B7	C3	n/a

NOTE: Testing is done to A4400-00 standards. Testing results are for single windows with no grilles & clear dual glass. Ratings higher than A3, B3 & C3 must be specified at time of order.

For PVC, grille & SDL options, please see pages 51-53.



## ENERGYSAVER 2500 SERIES

AWNING, BAY & BOW, CASEMENT, FIXED, PICTURE

The ultimate in energy efficiency, our top-of-the-line EnergySaver series windows meet all ENERGY STAR® zone requirements and achieve the highest CSA® ratings for wind, air and water resistance. The innovative design includes a gasket seal and warm edge spacer, plus a patented, multi-chambered PVC extrusion to keep outside temperatures from affecting the inside temperature of your home. You'll enjoy optimum noise reduction and excellent home security. And with the EnergySaver series, you can choose from our full selection of brickmould options with these windows for optimum curb appeal.

### FEATURES:

- Highest energy efficiency ratings
- Patented multi-chambered PVC extrusion, gasket seals and warm edge spacer keep outside temperatures out
- Excellent noise reduction
- Secured with multi-point locking system
- Wide selection of brickmoulds



**PICTURE FEATURES:**

**EnergySaver**

- Picture

- 1 Multi-chamber PVC extrusion
- 2 PVC interior heavy extruded glazing stop
- 3 Gasket glazing seal
- 4 Warm edge spacer
- 5 Coextruded dual gasket



**CASEMENT FEATURES:**

**EnergySaver**

-Fixed

- 1 Multi-chamber PVC extrusion
- 2 1.5" Renovation brickmould
- 3 PVC interior heavy extruded glazing stop
- 4 Gasket glazing seal
- 5 Warm edge spacer
- 6 Coextruded dual gasket
- 7 Triple weatherstripping to seal sash



	PERFORMANCE			
	Air Infiltration	Water Penetration	Wind Load	Forced Entry
2500 Picture	Fixed	B7	C4	n/a
2500 Awning	A3	B7	C3	F20
2500 Casement	A3	B7	C5	F20
2500 Fixed Sash	Fixed	B7	C3	n/a

NOTE: Testing is done to A4400-00 standards. Testing results are for single windows with no grilles & clear dual glass. Ratings higher than A3, B3 & C3 must be specified at time of order.

For PVC, hardware, grille & SDL options, please see pages 51-53.

**CASEMENT FEATURES:**

**Apex**

- V-weld casement

- 1 Warm edge spacer for improved energy performance
- 2 Fusion welded multiple chamber frame for superior energy performance
- 3 Integral nailing fin provides a barrier against the elements



# APEX 9100 SERIES

AWNING, CASEMENT, PICTURE

The Apex 9100's full PVC frame delivers great value and excellent energy efficiency. Triple weatherstripping and a warm edge spacer enhance the energy efficiency and overall performance of the design, virtually eliminating air and water leaks and providing greater comfort in your home. If you're installing Apex windows in combinations, our V-weld fusion-welded technology provides superior frame integrity and ensures far better wind and water performance than conventional combination windows.



**FUSION WELDED INSTEAD OF SCREWS VIRTUALLY ELIMINATES WATER LEAKS.**

*Read more on Page 6*

**FEATURES:**

- Ideal for 2 X 4 construction
- PVC frame
- Triple weatherstripping
- V-weld technology applied in combination installations

PERFORMANCE - 9100 SERIES WITH OR WITHOUT RENOLIT				
	Air Infiltration	Water Penetration	Wind Load	Forced Entry
9100 Awning	A3	B7	C3	F20
9100 Casement	A3	B7	C4	F20
9100 Picture	Fixed	B7	C4	n/a

NOTE: Testing is done to A4400-00 standards. Testing results are for single windows with no grilles & clear dual glass. Ratings higher than A3, B3 & C3 must be specified at time of order.

For PVC, hardware, grille & SDL options, please see pages 51-53.



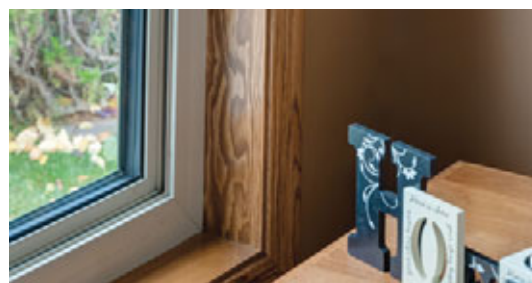

## APEX 9100 SERIES WITH RENOLIT

AWNING, CASEMENT, FIXED, PICTURE



FUSION WELDED INSTEAD OF SCREWS VIRTUALLY ELIMINATES WATER LEAKS.

*Read more on Page 6*

All the power and strength of our Apex 9100 Series combined with Renolit EXOFOL FX colour option, boosting your home's curb appeal while providing enhanced colour durability.

Proven in Europe with more than 35 years of practical use in a variety of climates, Renolit EXOFOL FX is a new option in Canada for applying colour to the exterior of PVC window frames that is bold, durable and long-lasting. This high-performance acrylic-based exterior film is permanently bonded to the exterior PVC window frame. Weather- and UV-resistant, the film retains its finish and colour unlike painted windows. The film is backed by a 10-year warranty and resists chalking, cracking or fading – even in seaside applications.

NOTE: Same performance as shown as the chart on opposite page.

### FEATURES:

All the features of the Apex 9100 series plus:

- Modern sash for a clean, bold look
- Fixed sash style for ensuring a seamless look when paired with casement or awning styles
- Optional 1 ½" or 2" Renovation Brickmould
- 5 exterior colours to choose from



*Rely on it.*



**FEATURES:**

- Ideal for 2 X 6 construction
- One-piece PVC frame
- Available tri-pane version for higher performance
- Superior insulation features

# TITAN 6500 SERIES

SINGLE SLIDER, PICTURE, SINGLE HUNG

Titan PVC windows take the performance of windows to a new level. The one-piece frame with set-back glass gives the windows better strength and durability, and improves resistance to water and air infiltration.

The tri-pane version pushes the energy efficiency of our Titan series to a much higher level, and gives you the best possible performance in a slider style window. Like our other PVC windows, the Titan features a multi-chamber PVC extrusion to provide improved insulation, a PVC drip lip to force water to drip down and away from your wall, and long-term durability with zero maintenance.

Titan is the window of choice when you need to replace windows in a true 2x6 wall.

**CENTRE WALL PLACEMENT**

By positioning the glass at the centre of the wall, we have built a warmer window. The inside temperature of the 6500 Titan PVC window is warmer with the sash moved to the interior. By bringing the window in closer to the inside wall, the circulation of room air against the window has improved. This helps reduce condensation by providing better ventilation at the inside of the window.

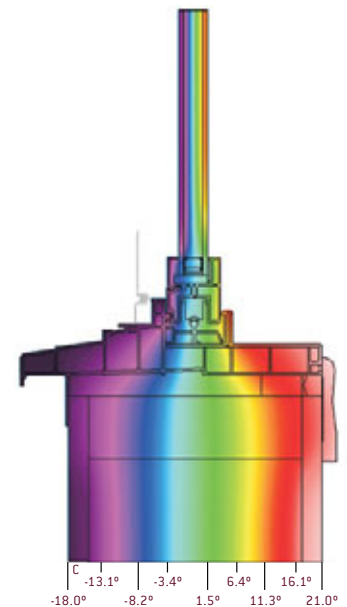

	PERFORMANCE			
	Air Infiltration	Water Penetration	Wind Load	Forced Entry
6500 Single Slider	A3/Fixed	B3	C4	F10
6500 Single Hung	A3/Fixed	B3	C4	F20
6500 Picture	Fixed	B7	C4	n/a

NOTE: Testing is done to A4400-00 standards. Testing results are for single windows with no grilles & clear dual glass. Ratings higher than A3, B3 & C3 must be specified at time of order. For PVC, grille & SDL options, please see pages 51-53.



## BASEMENT WINDOWS

DOUBLE SLIDER, HOPPER



ALL WEATHER WINDOWS RENOVATIONS offers a variety of options ideal for basement applications that are secure, energy efficient and designed to meet your needs. Whether you are looking to bring fresh air into your recreation room, you need pass-through space for large objects, or to meet fire escape codes for basement bedrooms, we have the window that's right for you.



The Hopper style basement window opens to a complete net clear opening, allowing you the flexibility to bring building materials such as drywall into the basement, and give you the ability to meet fire escape egress codes with smaller sized units.

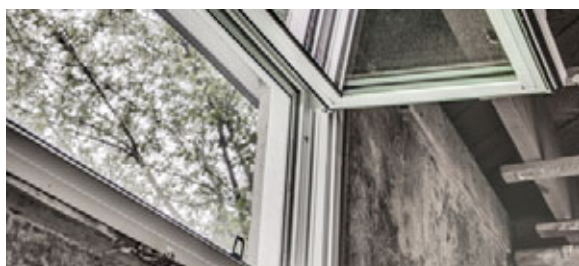

The Double Slider has both sides operational, sliding from side to side. You can also easily remove both sashes for cleaning and create a larger net clear opening if you need to bring building materials into the home.

### FEATURES:

- Energy efficient
- Removable sashes

	PERFORMANCE			
	Air Infiltration	Water Penetration	Wind Load	Forced Entry
Basement Hopper	A2	B2	C4	F2
Double Slider	A2	B2	C4	F2

NOTE: Testing is done to A4400-00 standards. Testing results are for single windows with no grilles & clear dual glass. Ratings higher than A3, B3 & C3 must be specified at time of order.

For PVC, grille & SDL options, please see pages 51-53.

# METAL CLAD EXTERIOR COLOURS

AVAILABLE ON APEX ALLOY WINDOWS  
AND VERSAILLE & WEATHERGARD SLIDING PATIO DOORS UNLESS OTHERWISE NOTED

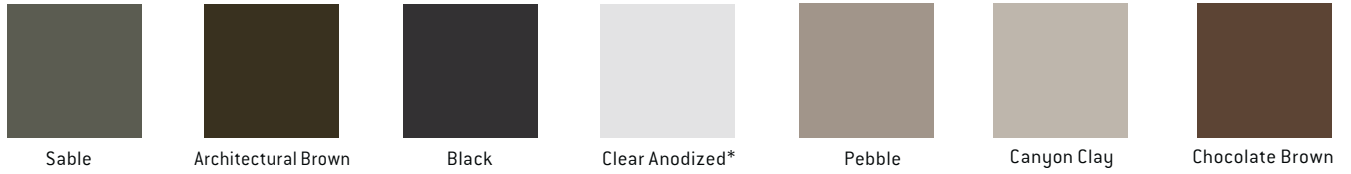

## Premium Exterior Clad Finishes

Wood Grain

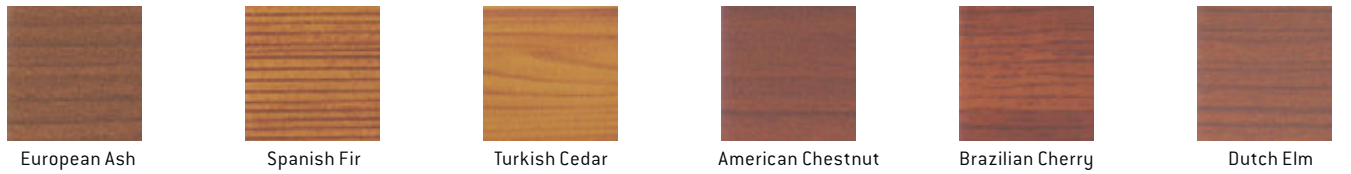

Solid



Metallic



\*Due to printing limitations colours may not be exactly as shown.

# PVC OPTIONS

## Interior Colours

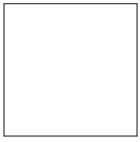

White



Wicker

## Brickmould Colours

### EnergySaver & Magnum windows

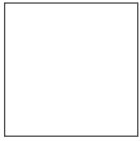

White



Wicker



Slate



Chocolate Brown



Forest Green



Canyon Clay



Pebble

Our EnergySaver and Magnum windows come with optional 1.5" and 2" PVC Brickmould.

## Apex 9100 Renolit Colours



Black



Architectural Brown



Sable

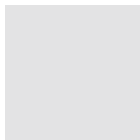

Clear Anodized



Pebble



## MULTI-LOCK HARDWARE

Added security for your home on our casement windows.



## HARDWARE OPTIONS

### ENCORE FOLDING HARDWARE

The Encore series features a sleek contemporary design, and the folding handle greatly reduces interference with curtains and blinds.

Availability:

- Standard on Apex Alloy & Apex 9100 casement & awning windows.
- Optional on EnergySaver casement & awning windows.



White



Wicker



Brushed Nickel\*

\* Colour availability varies by series - ask your All Weather Windows Renovations Sales Representative for more details.

### CONTOUR CRANK



White



Wicker

### MULTI-LOCK SYSTEM

Available on Apex Alloy, Apex, and EnergySaver operating windows.

\*Due to printing limitations colours may not be exactly as shown.

## GRILLE & SDL OPTIONS

### Internal Grilles

Internal grilles are installed in-between panes of glass to give a beautiful, maintenance-free, custom grille option.



#### Optional Grille Colours



Colours shown are approximate. Due to printing limitations, actual colours may vary slightly.

### Georgian Grille Split Finish

Split finish colours available on our Apex Alloy windows and our Versaille doors so you can match your grilles with your interior/exterior colours. Ask your sales representative for more details.

### SDLs (Simulated Divided Lites)

SDLs (Simulated Divided Lites) are installed on the exterior and interior of the glass to simulate the look of divided panes of glass. Individually divided panes of glass reduce energy efficiency by creating multiple seams and joints for every pane. With the simulated design the integrity of the glass is not compromised, thus maintaining energy efficiency. Our wood SDLs are for interior use only on Versaille and WeatherGard doors and can be stained and painted to match your interior colours.

2" simulated mullion also available.

#### Exterior Aluminum SDL Colours

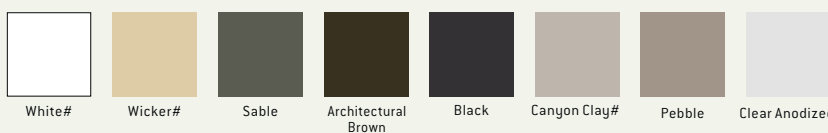

\* PVC windows and doors only  
# Wood doors only

#### Wood SDLs (wood doors only)



#### Aluminum SDLs (metal clad PVC windows and wood doors only)



Aluminum SDLs are for exterior use on select windows and doors.

#### Sample SDLs



### Patterns

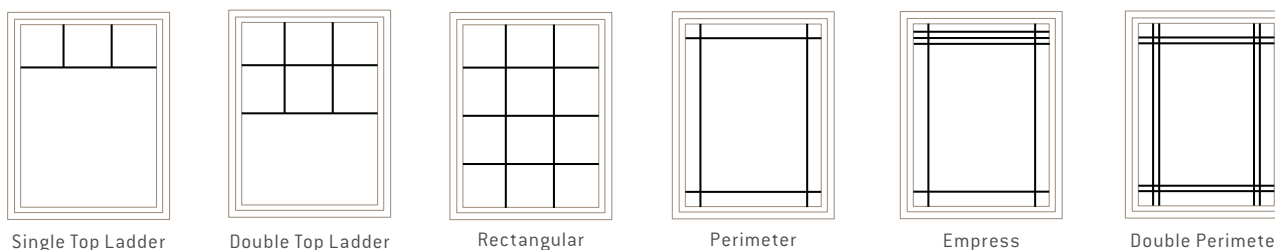

\*Due to printing limitations colours may not be exactly as shown.

# GLOSSARY

## **BRICKMOULD**

Brickmould is attached to the window or door frame on the exterior of a home. It covers the gap between your home's exterior and the window or door frame.

## **CLADDING**

Metal sheathing moulded and adhered to the outdoor sections of a window frame.

## **CSA® CERTIFICATION**

CSA® (Canadian Standards Association) provides product testing and certification services for a variety of products. Recognized internationally, a CSA® certification mark indicates that All Weather Windows' products have been tested by experts, and meet recognized standards for safety and performance.

## **DOOR JAMB**

For doors, the jamb is the vertical portion of the frame onto which a door is secured. The jamb holds the weight of the door through its hinges, making it a significant component to the overall durability and security of the door.

## **DRIP LIP**

An extruding edge that channels water away from the window and helps prevent it from dripping onto the wall under the window.

## **ENERGY STAR® QUALIFIED**

ENERGY STAR® is a third party assessment of the energy efficient of products. All Weather Windows proudly manufactures ENERGY STAR® qualified products including many that qualify for the "Most Efficient" program.

## **ER (Energy Rating)-RATING**

An ER-rating is derived from solar heat gain, heat loss through frames, centre and edge of glass, and air leakage heat loss. The combined effect is measured in number of watts per square metre and is either positive or negative. A positive number represents a net heat gain and helps in reducing the home's heating costs. A negative number indicates that the product loses more energy through heat loss and air infiltration than it gains in solar energy absorbed from the sun (i.e. the home's heating system has to work harder in colder weather).

## **FRAME**

Outer casing consisting of jambs and sills that encloses a window sash.

## **GRILLE**

Cross-bars in between the panes of glass to give the impression the window is divided into a number of smaller panes.

## **INTERIOR CASING**

Trim or frame around the window on the interior.

## **JOINERY**

The interlocking joints of window frames, casings, sashes etc.

## **MULLION**

A mullion is the vertical piece that connects side-by-side units of a window.

## **PASSIVE SOLAR HEAT GAIN**

Solar heat that passes through a material and is captured naturally, not by mechanical means.



**RAIL**

The horizontal part of a window sash on single-hung and double-hung windows.

**RELATIVE HEAT GAIN**

A calculated relationship of heat gain (through a window system) that accounts for centre-of-glass U-Value and centre-of-glass shading coefficient based on a standard inside and outside temperature.

**SASH**

The sash is the part of the window holding the glass in place when the window is being opened. They are available in sliding or hinged models, and create a tight seal with the frame when the window is closed.

**SHADING COEFFICIENT**

A glass measurement comparing solar heat transmission, related to 1/8 inch clear glass.

**SIDELITE**

Tall, narrow window installed beside a door.

**SILL**

The flat bottom part of a window or door frame.

**SPACER**

Spacers appear around the perimeter of the sealed glazing unit to provide uniform separation between the panes of glass in multiple-paned windows. They absorb moisture from the trapped air in the space between the glass, preventing fogging and condensation.

**STILES**

The vertical parts of a window sash (connected to rails, the horizontal parts).

**TRANSOM WINDOW**

A window installed above a door, separated by a crosspiece.

**U-VALUE**

A measure of the rate of non-solar heat flow through a material or assembly. The lower the U-Value, the greater a window's resistance to heat flow and the better its insulating value.

**VISIBLE LIGHT TRANSMITTANCE**

The percentage or fraction of the visible light spectrum that is transmitted through the glass of a window or skylight as reduced by the sash material and reluctance of the glass.

**WEATHERSTRIPPING**

Weatherstripping is a component of a window that provides a seal between the frame and the sash. It is used to prevent air leakage. The better the weatherstripping, the better the window performance.

**WINDOW JAMB**

Window jambs are located inside the framing of a window, along the top and sides for structural support. Inferior jambs can be a weak point in a window, allowing for leaks or security concerns.



## OVER 35+ YEAR HISTORY OF PROVIDING SUPERIOR WINDOWS AND DOORS

Founded in Edmonton in 1978 to create Canadian-made windows and doors designed specifically for unique Canadian climates, ALL WEATHER WINDOWS has grown to become one of the country's largest window and door manufacturers. With two leading-edge manufacturing facilities in Edmonton and Mississauga, several branches and over 1,000 dealers across the country, we serve the needs of Canadians from coast to coast.

From the very beginning, our focus has been on innovation, creating window and doors that are not only beautiful, but that exceed all standards for thermal efficiency and energy savings, so that you enjoy greater home comfort with lower environmental impact.

Our products include many industry firsts and award-winning designs, and meet the stringent performance requirements of CSA® Certification, ENERGY STAR® reclassification and North American Fenestration Standards. We're proud to have been recognized as ENERGY STAR® Manufacturer of the Year for two years in a row, and as one of "Canada's 50 Best Managed Companies".

You can trust ALL WEATHER WINDOWS RENOVATIONS to help you achieve a successful renovation that will add beauty and value to your home for years to come.

You can rest assured you'll get proper, professional installation, backed by our 5-year warranty on installation labour.





### WHERE TO FIND US:

Edmonton Renovations  
18550 – 118A Avenue  
Edmonton, AB T5S 2K7  
TF: 800-NEW-WINDOW  
F: 780-465-8958

Calgary Renovations  
10900 – 46 Street SE  
Calgary, AB T2C 1G4  
TF: 800-NEW-WINDOW  
F: 403-720-0050



Join the conversation. Professional advice, shared experiences, renovation tips, and more.



Learn more about renovating with All Weather Windows Renovations at [awwreno.com](http://awwreno.com)



## ALL WEATHER WINDOWS RENOVATIONS DOES DOORS **BEAUTIFULLY.**

### STYLE, SECURITY & ENERGY EFFICIENCY

When you set out to renovate your home, don't forget the first thing that people see – your doors! And for beautifully designed doors that will give your home a stunning facelift and increased value, look no further than All Weather Windows Renovations.

As with windows, we have over 35 years experience in the manufacture and installation of doors for Canadian homes. Choose front entry, patio and garden doors, from traditional to modern, bold to classic, in a range of materials to give you the look you want and the performance you need.



Learn more about renovating with ALL WEATHER  
WINDOWS RENOVATIONS at [awwreno.com](http://awwreno.com)